

# touchCUE-7-B

CS0452

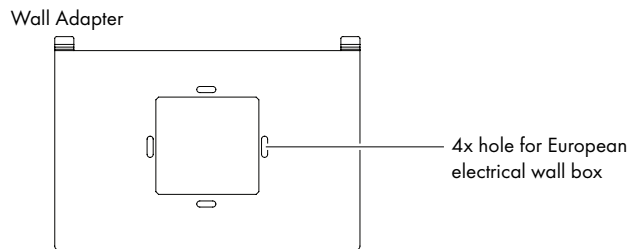

## Description

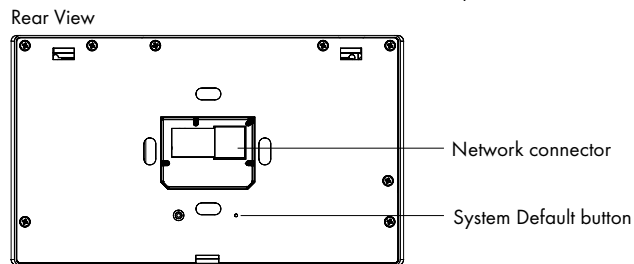
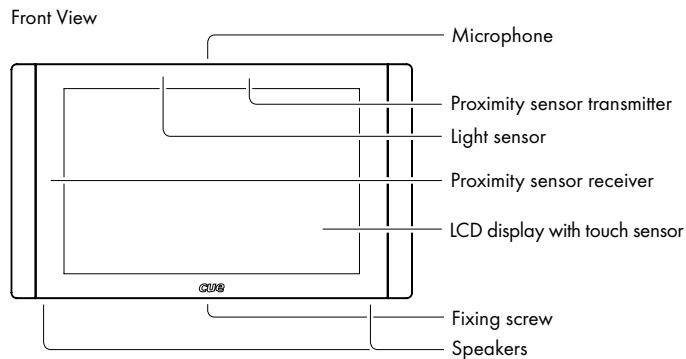

## Box Contents

Touch panel touchCUE-7-B incl. wall adapter  
Power supply with PoE injector incl. power cable  
Ethernet cable  
Cleaning tissue  
Data Sheet  
Cue System Connector Wiring Sheet  
Declaration of Conformity  
Warranty Conditions

## Connection

### Ethernet without PoE Infrastructure

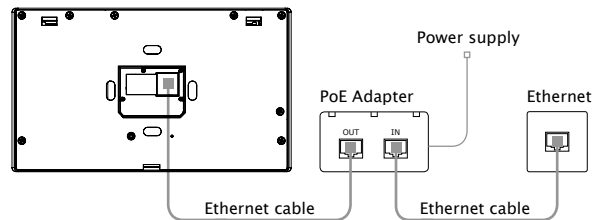

### Ethernet with PoE Infrastructure

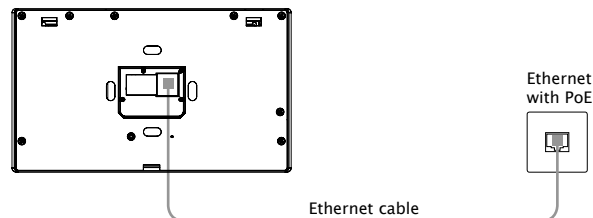

## System Default Setup

When System Default button is pressed, the system default function is performed and setup is as follows

- IP address: from DHCP
- IP Mask: from DHCP
- Password: Empty (no input required)
- Alternate IP address (network without DHCP server): 192.168.1.128
- Alternate IP mask: 255.255.255.0

## User Manual

Complete user manual can be downloaded here:  
[http://www.cuesystem.com/user\\_manuals.aspx](http://www.cuesystem.com/user_manuals.aspx)

## Installation

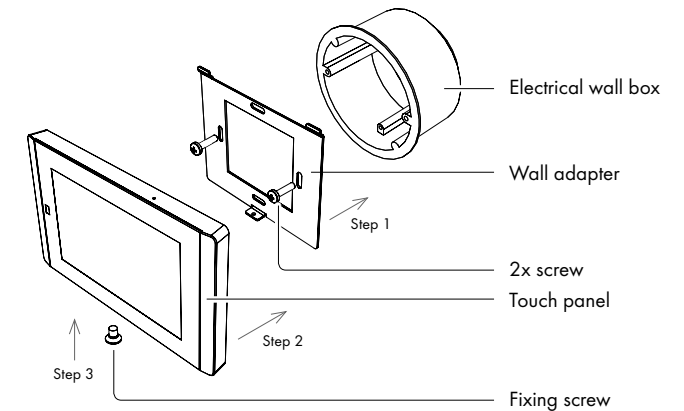

Installation steps are as follows

1. Install wall adapter on the electrical wall box.  
**Use delivered screws** or keep maximum screw dimensions as described below.

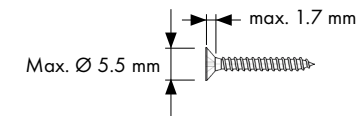

2. Connect network cable and put the touch panel on the wall adapter.

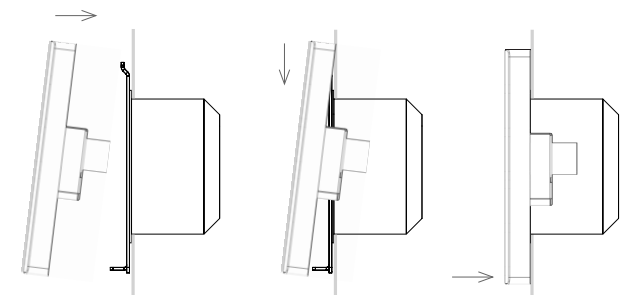

3. Carefully tighten the fixing screw to fix touch panel on the wall.